



AiP74HC/HCT157

Quad 2-input Multiplexer

Product Specification

Specification Revision History:

Version	Date	Description
2012-06-A1	2012-06	New
2023-04-B1	2023-04	Update the template



Contents

1、 General Description.....	3
2、 Block Diagram And Pin Description	6
2.1、 Block Diagram	6
2.2、 Pin Configurations.....	7
2.3、 Pin Description	7
2.4、 Function Table.....	8
3、 Electrical Parameter	8
3.1、 Absolute Maximum Ratings.....	8
3.2、 Recommended Operating Conditions	8
3.3、 Electrical Characteristics	9
3.3.1、 DC Characteristics 1	9
3.3.2、 DC Characteristics 2	10
3.3.3、 DC Characteristics 3	11
3.3.4、 AC Characteristics 1	12
3.3.5、 AC Characteristics 2	13
3.3.6、 AC Characteristics 3	14
4、 Testing Circuit	15
4.1、 AC Testing Circuit	15
4.2、 AC Testing Waveforms.....	15
4.3、 Measurement Points	16
4.4、 Test Data	16
5、 Package Information	17
5.1、 DIP16	17
5.2、 SOP16	18
5.3、 TSSOP16.....	19
6、 Statements And Notes	20
6.1、 The name and content of Hazardous substances or Elements in the product	20
6.2、 Notes	20



1、 General Description

The AiP74HC/HCT157 are quad 2-input multiplexers which select 4 bits of data from two sources under the control of a common data select input (S). The enable input (\bar{E}) is active LOW. When \bar{E} is HIGH, all of the outputs (1Y to 4Y) are forced LOW regardless of all other input conditions.

Moving the data from two groups of registers to four common output buses is a common use of the AiP74HC/HCT157. The state of the common data select input (S) determines the particular register from which the data comes. It can also be used as function generator. The device is useful for implementing highly irregular logic by generating any four of the 16 different functions of two variables with one variable common. The AiP74HC/HCT157 is logic implementation of a 4-pole, 2-position switch, where the position of the switch is determined by the logic levels applied to S.

The logic equations are:

$$1Y = \bar{E} \times (1I1 \times S + 1I0 \times \bar{S})$$

$$2Y = \bar{E} \times (2I1 \times S + 2I0 \times \bar{S})$$

$$3Y = \bar{E} \times (3I1 \times S + 3I0 \times \bar{S})$$

$$4Y = \bar{E} \times (4I1 \times S + 4I0 \times \bar{S})$$

The AiP74HC/HCT157 is identical to the AiP74HC/HCT158 but has non-inverting (true) outputs.

Features:

- Input levels:
 - For AiP74HC157: CMOS level
 - For AiP74HCT157: TTL level
- Low-power dissipation
- Non-inverting data path
- Specified from -40°C to +125°C
- Packaging information: DIP16/SOP16/TSSOP16

**Ordering Information:****Tube packing specifications:**

Part number	Packaging form	Marking code	Tube quantity	Boxed tube quantity	Boxed quantity	Notes
AiP74HC157DA16.TB	DIP16	74HC157	25 PCS/tube	40 tube/box	1000 PCS/box	Dimensions of plastic enclosure: 19.0mm×6.4mm Pin spacing: 2.54mm
AiP74HCT157DA16.TB	DIP16	74HCT157	25 PCS/tube	40 tube/box	1000 PCS/box	Dimensions of plastic enclosure: 19.0mm×6.4mm Pin spacing: 2.54mm
AiP74HC157SA16.TB	SOP16	74HC157	50 PCS/tube	200 tube/box	10000 PCS/box	Dimensions of plastic enclosure: 10.0mm×3.9mm Pin spacing: 1.27mm
AiP74HCT157SA16.TB	SOP16	74HCT157	50 PCS/tube	200 tube/box	10000 PCS/box	Dimensions of plastic enclosure: 10.0mm×3.9mm Pin spacing: 1.27mm
AiP74HC157TA16.TB	TSSOP16	74HC157	96 PCS/tube	200 tube/box	19200 PCS/box	Dimensions of plastic enclosure: 5.0mm×4.4mm Pin spacing: 0.65mm
AiP74HCT157TA16.TB	TSSOP16	74HCT157	96 PCS/tube	200 tube/box	19200 PCS/box	Dimensions of plastic enclosure: 5.0mm×4.4mm Pin spacing: 0.65mm



Reel packing specifications:

Part number	Packaging form	Marking code	Reel quantity	Boxed reel quantity	Notes
AiP74HC157SA16.TR	SOP16	74HC157	4000 PCS/reel	8000 PCS/box	Dimensions of plastic enclosure: 10.0mm×3.9mm Pin spacing:1.27mm
AiP74HCT157SA16.TR	SOP16	74HCT157	4000 PCS/reel	8000 PCS/box	Dimensions of plastic enclosure: 10.0mm×3.9mm Pin spacing:1.27mm
AiP74HC157TA16.TR	TSSOP16	74HC157	5000 PCS/reel	10000 PCS/box	Dimensions of plastic enclosure: 5.0mm×4.4mm Pin spacing:0.65mm
AiP74HCT157TA16.TR	TSSOP16	74HCT157	5000 PCS/reel	10000 PCS/box	Dimensions of plastic enclosure: 5.0mm×4.4mm Pin spacing:0.65mm

Note: If the physical information is inconsistent with the ordering information, please refer to the actual product.



2、Block Diagram And Pin Description

2.1、Block Diagram

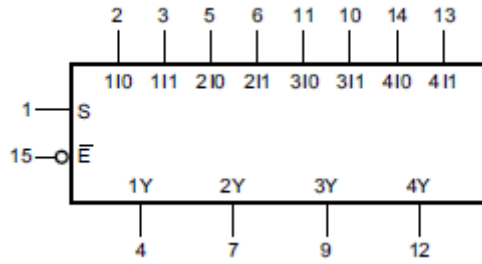

Figure 1. Logic symbol

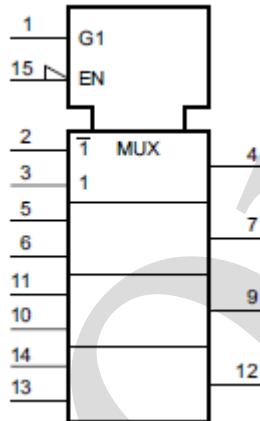

Figure 2. IEC logic symbol

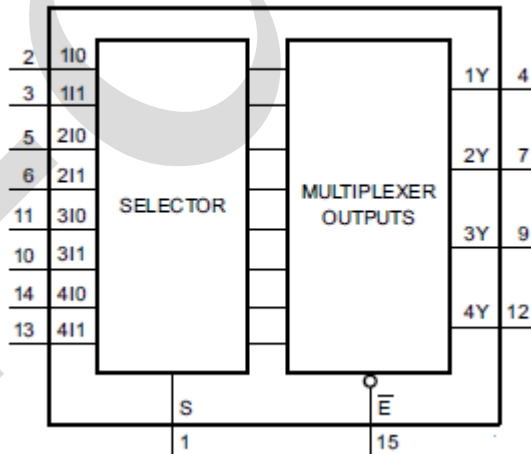

Figure 3. Functional diagram

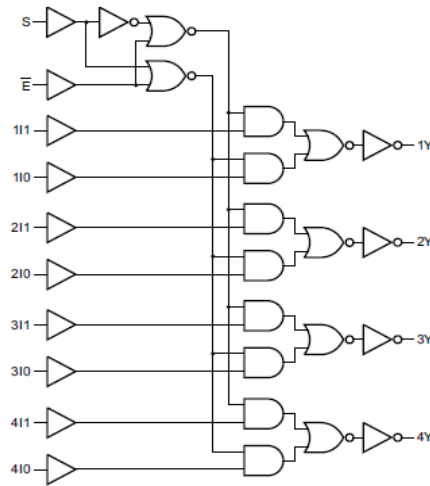
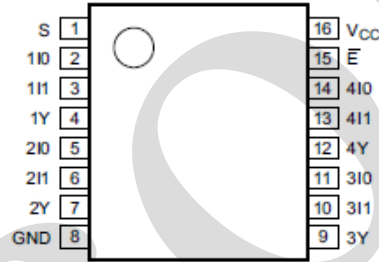

Figure 4. Logic diagram

2.2、 Pin Configurations



2.3、 Pin Description

Pin No.	Pin Name	Description
1	S	common data select input
2	1I0	data input from source 0
3	1I1	data input from source 1
4	1Y	multiplexer output
5	2I0	data input from source 0
6	2I1	data input from source 1
7	2Y	multiplexer output
8	GND	ground (0V)
9	3Y	multiplexer output
10	3I1	data input from source 1
11	3I0	data input from source 0
12	4Y	multiplexer output
13	4I1	data input from source 1
14	4I0	data input from source 0
15	\bar{E}	enable input (active LOW)
16	V _{CC}	supply voltage



2.4、Function Table

Input				Output
\bar{E}	S	nI0	nI1	nY
H	X	X	X	L
L	L	L	X	L
L	L	H	X	H
L	H	X	L	L
L	H	X	H	H

Note: H=HIGH voltage level; L=LOW voltage level; X=don't care.

3、Electrical Parameter

3.1、Absolute Maximum Ratings

(Voltages are referenced to GND (ground=0V), unless otherwise specified.)

Parameter	Symbol	Conditions	Min.	Max.	Unit
supply voltage	V_{CC}	-	-0.5	+7.0	V
input clamping current	I_{IK}	$V_I < -0.5V$ or $V_I > V_{CC}+0.5V$	-	± 20	mA
output clamping current	I_{OK}	$V_O < -0.5V$ or $V_O > V_{CC}+0.5V$	-	± 20	mA
output current	I_O	$V_O = -0.5V$ to $(V_{CC}+0.5V)$	-	± 25	mA
supply current	I_{CC}	-	-	+50	mA
ground current	I_{GND}	-	-50	-	mA
storage temperature	T_{stg}	-	-65	+150	$^{\circ}C$
total power dissipation	P_{tot}	-	-	500	mW
soldering temperature	T_L	10s	DIP	245	$^{\circ}C$
			SOP/TSSOP	260	$^{\circ}C$

3.2、Recommended Operating Conditions

Parameter	Symbol	Conditions	Min.	Typ.	Max.	Unit
AiP74HC157						
supply voltage	V_{CC}	-	2.0	5.0	6.0	V
input voltage	V_I	-	0	-	V_{CC}	V
output voltage	V_O	-	0	-	V_{CC}	V
input transition rise and fall rate	$\Delta t/\Delta V$	$V_{CC}=2.0V$	-	-	625	ns/V
		$V_{CC}=4.5V$	-	1.67	139	ns/V
		$V_{CC}=6.0V$	-	-	83	ns/V
ambient temperature	T_{amb}	-	-40	-	+125	$^{\circ}C$
AiP74HCT157						
supply voltage	V_{CC}	-	4.5	5.0	5.5	V
input voltage	V_I	-	0	-	V_{CC}	V
output voltage	V_O	-	0	-	V_{CC}	V
input transition rise and fall rate	$\Delta t/\Delta V$	$V_{CC}=4.5V$	-	1.67	139	ns/V
ambient temperature	T_{amb}	-	-40	-	+125	$^{\circ}C$



3.3、Electrical Characteristics

3.3.1、DC Characteristics 1

($T_{amb}=25^{\circ}C$, voltages are referenced to GND (ground=0V), unless otherwise specified.)

Parameter	Symbol	Conditions	Min.	Typ.	Max.	Unit	
AiP74HC157							
HIGH-level input voltage	V_{IH}	$V_{CC}=2.0V$	1.5	1.2	-	V	
		$V_{CC}=4.5V$	3.15	2.4	-	V	
		$V_{CC}=6.0V$	4.2	3.2	-	V	
LOW-level input voltage	V_{IL}	$V_{CC}=2.0V$	-	0.8	0.5	V	
		$V_{CC}=4.5V$	-	2.1	1.35	V	
		$V_{CC}=6.0V$	-	2.8	1.8	V	
HIGH-level output voltage	V_{OH}	$V_I=V_{IH}$ or V_{IL}	$I_O=-20\mu A; V_{CC}=2.0V$	1.9	2.0	-	V
			$I_O=-20\mu A; V_{CC}=4.5V$	4.4	4.5	-	V
			$I_O=-20\mu A; V_{CC}=6.0V$	5.9	6.0	-	V
			$I_O=-4.0mA; V_{CC}=4.5V$	3.98	4.32	-	V
			$I_O=-5.2mA; V_{CC}=6.0V$	5.48	5.81	-	V
LOW-level output voltage	V_{OL}	$V_I=V_{IH}$ or V_{IL}	$I_O=20\mu A; V_{CC}=2.0V$	-	0	0.1	V
			$I_O=20\mu A; V_{CC}=4.5V$	-	0	0.1	V
			$I_O=20\mu A; V_{CC}=6.0V$	-	0	0.1	V
			$I_O=4.0mA; V_{CC}=4.5V$	-	0.15	0.26	V
			$I_O=5.2mA; V_{CC}=6.0V$	-	0.16	0.26	V
input leakage current	I_I	$V_I=V_{CC}$ or GND; $V_{CC}=6.0V$	-	-	± 1.0	μA	
supply current	I_{CC}	$V_I=V_{CC}$ or GND; $I_O=0A; V_{CC}=6.0V$	-	-	8.0	μA	
input capacitance	C_I	-	-	3.5	-	pF	
AiP74HCT157							
HIGH-level input voltage	V_{IH}	$V_{CC}=4.5V$ to $5.5V$	2.0	1.6	-	V	
LOW-level input voltage	V_{IL}	$V_{CC}=4.5V$ to $5.5V$	-	1.2	0.8	V	
HIGH-level output voltage	V_{OH}	$V_I=V_{IH}$ or $V_{IL}; V_{CC}=4.5V$	$I_O=-20\mu A$	4.4	4.5	-	V
			$I_O=-4.0mA$	3.98	4.32	-	V
LOW-level output voltage	V_{OL}	$V_I=V_{IH}$ or $V_{IL}; V_{CC}=4.5V$	$I_O=20\mu A$	-	0	0.1	V
			$I_O=4.0mA$	-	0.15	0.26	V
input leakage current	I_I	$V_I=V_{CC}$ or GND; $V_{CC}=5.5V$	-	-	± 1.0	μA	
supply current	I_{CC}	$V_I=V_{CC}$ or GND; $I_O=0A; V_{CC}=5.5V$	-	-	8.0	μA	
additional supply current	ΔI_{CC}	$V_I=V_{CC}-2.1V;$ other inputs at V_{CC} or GND; $I_O=0A;$ $V_{CC}=4.5V$ to $5.5V$	per input pin; nI0, nI1 inputs	-	-	360	μA
			per input pin; \bar{E} input	-	-	216	μA
			per input pin; S input	-	-	360	μA
input capacitance	C_I	-	-	3.5	-	pF	



3.3.2、DC Characteristics 2

($T_{amb}=-40^{\circ}\text{C}$ to $+85^{\circ}\text{C}$, voltages are referenced to GND (ground=0V), unless otherwise specified.)

Parameter	Symbol	Conditions	Min.	Typ.	Max.	Unit	
AiP74HC157							
HIGH-level input voltage	V_{IH}	$V_{CC}=2.0\text{V}$	1.5	-	-	V	
		$V_{CC}=4.5\text{V}$	3.15	-	-	V	
		$V_{CC}=6.0\text{V}$	4.2	-	-	V	
LOW-level input voltage	V_{IL}	$V_{CC}=2.0\text{V}$	-	-	0.5	V	
		$V_{CC}=4.5\text{V}$	-	-	1.35	V	
		$V_{CC}=6.0\text{V}$	-	-	1.8	V	
HIGH-level output voltage	V_{OH}	$V_I=V_{IH}$ or V_{IL}	$I_O=-20\mu\text{A}; V_{CC}=2.0\text{V}$	1.9	-	-	V
			$I_O=-20\mu\text{A}; V_{CC}=4.5\text{V}$	4.4	-	-	V
			$I_O=-20\mu\text{A}; V_{CC}=6.0\text{V}$	5.9	-	-	V
			$I_O=-4.0\text{mA}; V_{CC}=4.5\text{V}$	3.84	-	-	V
			$I_O=-5.2\text{mA}; V_{CC}=6.0\text{V}$	5.34	-	-	V
LOW-level output voltage	V_{OL}	$V_I=V_{IH}$ or V_{IL}	$I_O=20\mu\text{A}; V_{CC}=2.0\text{V}$	-	-	0.1	V
			$I_O=20\mu\text{A}; V_{CC}=4.5\text{V}$	-	-	0.1	V
			$I_O=20\mu\text{A}; V_{CC}=6.0\text{V}$	-	-	0.1	V
			$I_O=4.0\text{mA}; V_{CC}=4.5\text{V}$	-	-	0.33	V
			$I_O=5.2\text{mA}; V_{CC}=6.0\text{V}$	-	-	0.33	V
input leakage current	I_I	$V_I=V_{CC}$ or GND; $V_{CC}=6.0\text{V}$	-	-	± 1.0	μA	
supply current	I_{CC}	$V_I=V_{CC}$ or GND; $I_O=0\text{A}; V_{CC}=6.0\text{V}$	-	-	80	μA	
AiP74HCT157							
HIGH-level input voltage	V_{IH}	$V_{CC}=4.5\text{V}$ to 5.5V	2.0	-	-	V	
LOW-level input voltage	V_{IL}	$V_{CC}=4.5\text{V}$ to 5.5V	-	-	0.8	V	
HIGH-level output voltage	V_{OH}	$V_I=V_{IH}$ or $V_{IL}; V_{CC}=4.5\text{V}$	$I_O=-20\mu\text{A}$	4.4	-	-	V
			$I_O=-4.0\text{mA}$	3.84	-	-	V
LOW-level output voltage	V_{OL}	$V_I=V_{IH}$ or $V_{IL}; V_{CC}=4.5\text{V}$	$I_O=20\mu\text{A}$	-	-	0.1	V
			$I_O=4.0\text{mA}$	-	-	0.33	V
input leakage current	I_I	$V_I=V_{CC}$ or GND; $V_{CC}=5.5\text{V}$	-	-	± 1.0	μA	
supply current	I_{CC}	$V_I=V_{CC}$ or GND; $I_O=0\text{A}; V_{CC}=5.5\text{V}$	-	-	80	μA	
additional supply current	ΔI_{CC}	$V_I=V_{CC}-2.1\text{V};$ other inputs at V_{CC} or GND; $I_O=0\text{A};$ $V_{CC}=4.5\text{V}$ to 5.5V	per input pin; nI0, nI1 inputs	-	-	450	μA
			per input pin; \bar{E} input	-	-	270	μA
			per input pin; S input	-	-	450	μA



3.3.3、DC Characteristics 3

($T_{amb}=-40^{\circ}\text{C}$ to $+125^{\circ}\text{C}$, voltages are referenced to GND (ground=0V), unless otherwise specified.)

Parameter	Symbol	Conditions	Min.	Typ.	Max.	Unit	
AiP74HC157							
HIGH-level input voltage	V_{IH}	$V_{CC}=2.0\text{V}$	1.5	-	-	V	
		$V_{CC}=4.5\text{V}$	3.15	-	-	V	
		$V_{CC}=6.0\text{V}$	4.2	-	-	V	
LOW-level input voltage	V_{IL}	$V_{CC}=2.0\text{V}$	-	-	0.5	V	
		$V_{CC}=4.5\text{V}$	-	-	1.35	V	
		$V_{CC}=6.0\text{V}$	-	-	1.8	V	
HIGH-level output voltage	V_{OH}	$V_I=V_{IH}$ or V_{IL}	$I_O=-20\mu\text{A}; V_{CC}=2.0\text{V}$	1.9	-	-	V
			$I_O=-20\mu\text{A}; V_{CC}=4.5\text{V}$	4.4	-	-	V
			$I_O=-20\mu\text{A}; V_{CC}=6.0\text{V}$	5.9	-	-	V
			$I_O=-4.0\text{mA}; V_{CC}=4.5\text{V}$	3.7	-	-	V
			$I_O=-5.2\text{mA}; V_{CC}=6.0\text{V}$	5.2	-	-	V
LOW-level output voltage	V_{OL}	$V_I=V_{IH}$ or V_{IL}	$I_O=20\mu\text{A}; V_{CC}=2.0\text{V}$	-	-	0.1	V
			$I_O=20\mu\text{A}; V_{CC}=4.5\text{V}$	-	-	0.1	V
			$I_O=20\mu\text{A}; V_{CC}=6.0\text{V}$	-	-	0.1	V
			$I_O=4.0\text{mA}; V_{CC}=4.5\text{V}$	-	-	0.4	V
			$I_O=5.2\text{mA}; V_{CC}=6.0\text{V}$	-	-	0.4	V
input leakage current	I_I	$V_I=V_{CC}$ or GND; $V_{CC}=6.0\text{V}$	-	-	± 1.0	μA	
supply current	I_{CC}	$V_I=V_{CC}$ or GND; $I_O=0\text{A}; V_{CC}=6.0\text{V}$	-	-	160	μA	
AiP74HCT157							
HIGH-level input voltage	V_{IH}	$V_{CC}=4.5\text{V}$ to 5.5V	2.0	-	-	V	
LOW-level input voltage	V_{IL}	$V_{CC}=4.5\text{V}$ to 5.5V	-	-	0.8	V	
HIGH-level output voltage	V_{OH}	$V_I=V_{IH}$ or $V_{IL}; V_{CC}=4.5\text{V}$	$I_O=-20\mu\text{A}$	4.4	-	-	V
			$I_O=-4.0\text{mA}$	3.7	-	-	V
LOW-level output voltage	V_{OL}	$V_I=V_{IH}$ or $V_{IL}; V_{CC}=4.5\text{V}$	$I_O=20\mu\text{A}$	-	-	0.1	V
			$I_O=4.0\text{mA}$	-	-	0.4	V
input leakage current	I_I	$V_I=V_{CC}$ or GND; $V_{CC}=5.5\text{V}$	-	-	± 1.0	μA	
supply current	I_{CC}	$V_I=V_{CC}$ or GND; $I_O=0\text{A}; V_{CC}=5.5\text{V}$	-	-	160	μA	
additional supply current	ΔI_{CC}	$V_I=V_{CC}-2.1\text{V};$ other inputs at V_{CC} or GND; $I_O=0\text{A};$ $V_{CC}=4.5\text{V}$ to 5.5V	per input pin; nI0, nI1 inputs	-	-	490	μA
			per input pin; \bar{E} input	-	-	294	μA
			per input pin; S input	-	-	490	μA



3.3.4、AC Characteristics 1

($T_{amb}=25^{\circ}C$, $GND=0V$, $C_L=50pF$, unless otherwise specified.)

Parameter	Symbol	Conditions	Min.	Typ.	Max.	Unit	
AiP74HC157							
propagation delay	t_{pd}	nI0, nI1 to nY; see Figure 6 ^[1]	$V_{CC}=2.0V$	-	36	125	ns
			$V_{CC}=4.5V$	-	13	25	ns
			$V_{CC}=5.0V$; $C_L=15pF$	-	11	-	ns
			$V_{CC}=6.0V$	-	10	21	ns
		S to nY; see Figure 6 ^[1]	$V_{CC}=2.0V$	-	41	125	ns
			$V_{CC}=4.5V$	-	15	25	ns
			$V_{CC}=5.0V$; $C_L=15pF$	-	12	-	ns
			$V_{CC}=6.0V$	-	12	21	ns
		\bar{E} to nY; see Figure 7 ^[1]	$V_{CC}=2.0V$	-	39	115	ns
			$V_{CC}=4.5V$	-	14	23	ns
			$V_{CC}=5.0V$; $C_L=15pF$	-	11	-	ns
			$V_{CC}=6.0V$	-	11	20	ns
transition time	t_t	nY; see Figure 6 ^[2]	$V_{CC}=2.0V$	-	19	75	ns
			$V_{CC}=4.5V$	-	7	15	ns
			$V_{CC}=6.0V$	-	6	13	ns
power dissipation capacitance	C_{PD}	$C_L=50pF$; $f=1MHz$; $V_I=GND$ to V_{CC} ^[3]	-	70	-	pF	
AiP74HCT157							
propagation delay	t_{pd}	nI0, nI1 to nY; see Figure 6 ^[1]	$V_{CC}=4.5V$	-	16	27	ns
			$V_{CC}=5.0V$; $C_L=15pF$	-	13	-	ns
		S to nY; see Figure 6 ^[1]	$V_{CC}=4.5V$	-	22	37	ns
			$V_{CC}=5.0V$; $C_L=15pF$	-	19	-	ns
		\bar{E} to nY; see Figure 7 ^[1]	$V_{CC}=4.5V$	-	15	26	ns
		$V_{CC}=5.0V$; $C_L=15pF$	-	12	-	ns	
transition time	t_t	nY; $V_{CC}=4.5V$; see Figure 6 ^[2]	-	7	15	ns	
power dissipation capacitance	C_{PD}	$C_L=50pF$; $f=1MHz$; $V_I=GND$ to $V_{CC}-1.5V$ ^[3]	-	70	-	pF	

Note:

[1] t_{pd} is the same as t_{PLH} and t_{PHL} .

[2] t_t is the same as t_{THL} and t_{TLH} .

[3] C_{PD} is used to determine the dynamic power dissipation (P_D in uW).

$$P_D = C_{PD} \times V_{CC}^2 \times f_i \times N + \sum (C_L \times V_{CC}^2 \times f_o) \text{ where:}$$

f_i =input frequency in MHz;

f_o =output frequency in MHz;

C_L =output load capacitance in pF;

V_{CC} =supply voltage in V;

N =number of inputs switching;

$\sum (C_L \times V_{CC}^2 \times f_o)$ =sum of outputs.



3.3.5、AC Characteristics 2

($T_{amb}=-40^{\circ}\text{C}$ to $+85^{\circ}\text{C}$, $GND=0\text{V}$, $C_L=50\text{pF}$, unless otherwise specified.)

Parameter	Symbol	Conditions	Min.	Typ.	Max.	Unit	
AiP74HC157							
propagation delay	t_{pd}	nI0, nI1 to nY; see Figure 6 ^[1]	$V_{CC}=2.0\text{V}$	-	-	155	ns
			$V_{CC}=4.5\text{V}$	-	-	31	ns
			$V_{CC}=6.0\text{V}$	-	-	26	ns
		S to nY; see Figure 6 ^[1]	$V_{CC}=2.0\text{V}$	-	-	155	ns
			$V_{CC}=4.5\text{V}$	-	-	31	ns
			$V_{CC}=6.0\text{V}$	-	-	26	ns
		\bar{E} to nY; see Figure 7 ^[1]	$V_{CC}=2.0\text{V}$	-	-	145	ns
			$V_{CC}=4.5\text{V}$	-	-	29	ns
			$V_{CC}=6.0\text{V}$	-	-	25	ns
transition time	t_t	nY; see Figure 6 ^[2]	$V_{CC}=2.0\text{V}$	-	-	95	ns
			$V_{CC}=4.5\text{V}$	-	-	19	ns
			$V_{CC}=6.0\text{V}$	-	-	16	ns
AiP74HCT157							
propagation delay	t_{pd}	nI0, nI1 to nY; see Figure 6 ^[1]	$V_{CC}=4.5\text{V}$	-	-	34	ns
		S to nY; see Figure 6 ^[1]	$V_{CC}=4.5\text{V}$	-	-	46	ns
		\bar{E} to nY; see Figure 7 ^[1]	$V_{CC}=4.5\text{V}$	-	-	33	ns
transition time	t_t	nY; $V_{CC}=4.5\text{V}$; see Figure 6 ^[2]	-	-	19	ns	

Note:

[1] t_{pd} is the same as t_{PLH} and t_{PHL} .

[2] t_t is the same as t_{THL} and t_{TLH} .



3.3.6、AC Characteristics 3

($T_{amb} = -40^{\circ}\text{C}$ to $+125^{\circ}\text{C}$, $GND = 0\text{V}$, $C_L = 50\text{pF}$, unless otherwise specified.)

Parameter	Symbol	Conditions	Min.	Typ.	Max.	Unit	
AiP74HC157							
propagation delay	t_{pd}	nI0, nI1 to nY; see Figure 6 ^[1]	$V_{CC} = 2.0\text{V}$	-	-	190	ns
			$V_{CC} = 4.5\text{V}$	-	-	38	ns
			$V_{CC} = 6.0\text{V}$	-	-	32	ns
		S to nY; see Figure 6 ^[1]	$V_{CC} = 2.0\text{V}$	-	-	190	ns
			$V_{CC} = 4.5\text{V}$	-	-	38	ns
			$V_{CC} = 6.0\text{V}$	-	-	32	ns
		\bar{E} to nY; see Figure 7 ^[1]	$V_{CC} = 2.0\text{V}$	-	-	175	ns
			$V_{CC} = 4.5\text{V}$	-	-	35	ns
			$V_{CC} = 6.0\text{V}$	-	-	30	ns
transition time	t_t	nY; see Figure 6 ^[2]	$V_{CC} = 2.0\text{V}$	-	-	110	ns
			$V_{CC} = 4.5\text{V}$	-	-	22	ns
			$V_{CC} = 6.0\text{V}$	-	-	19	ns
AiP74HCT157							
propagation delay	t_{pd}	nI0, nI1 to nY; see Figure 6 ^[1]	$V_{CC} = 4.5\text{V}$	-	-	41	ns
		S to nY; see Figure 6 ^[1]	$V_{CC} = 4.5\text{V}$	-	-	56	ns
		\bar{E} to nY; see Figure 7 ^[1]	$V_{CC} = 4.5\text{V}$	-	-	39	ns
transition time	t_t	nY; $V_{CC} = 4.5\text{V}$; see Figure 6 ^[2]	-	-	22	ns	

Note:

[1] t_{pd} is the same as t_{PLH} and t_{PHL} .

[2] t_t is the same as t_{THL} and t_{TLH} .



4、 Testing Circuit

4.1、 AC Testing Circuit

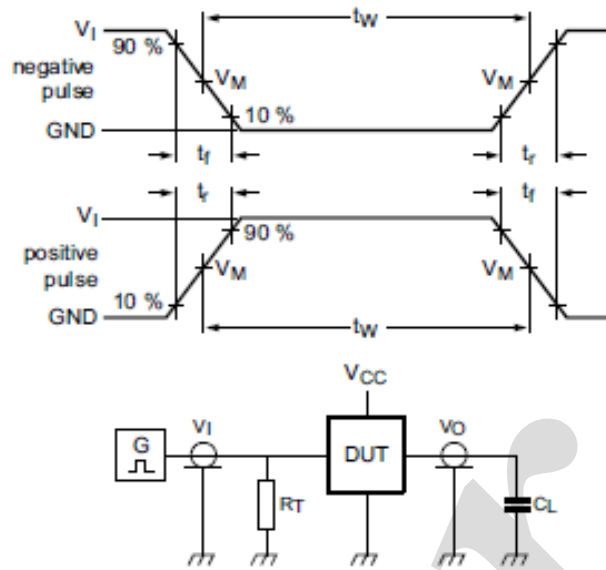

Figure 5. Test circuit for measuring switching times

Definitions for test circuit:

C_L =Load capacitance including jig and probe capacitance.

R_T =Termination resistance should be equal to the output impedance Z_o of the pulse generator.

4.2、 AC Testing Waveforms

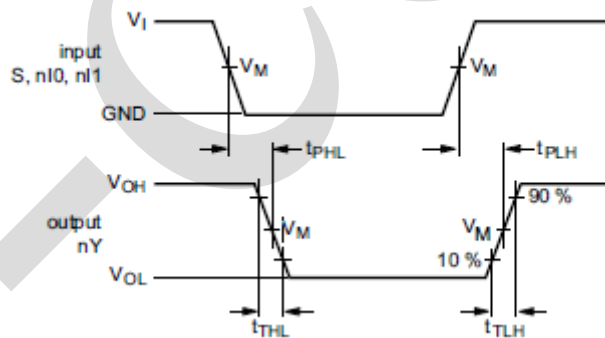
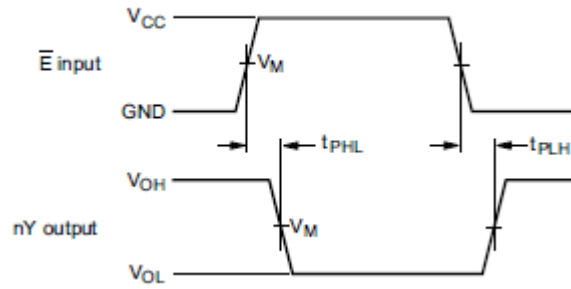

Figure 6. Propagation delay input (nI0, nI1, S) to output (nYn)

Figure 7. Propagation delay input (\bar{E}) to output (nY)

4.3. Measurement Points

Type	Input	Output
	V_M	V_M
AiP74HC157	$0.5 \times V_{CC}$	$0.5 \times V_{CC}$
AiP74HCT157	1.3V	1.3V

4.4. Test Data

Type	Input		Load	Test
	V_I	t_r, t_f	C_L	
AiP74HC157	V_{CC}	6ns	15pF, 50pF	t_{PHL}, t_{PLH}
AiP74HCT157	3V	6ns	15pF, 50pF	t_{PHL}, t_{PLH}



5、Package Information

5.1、DIP16

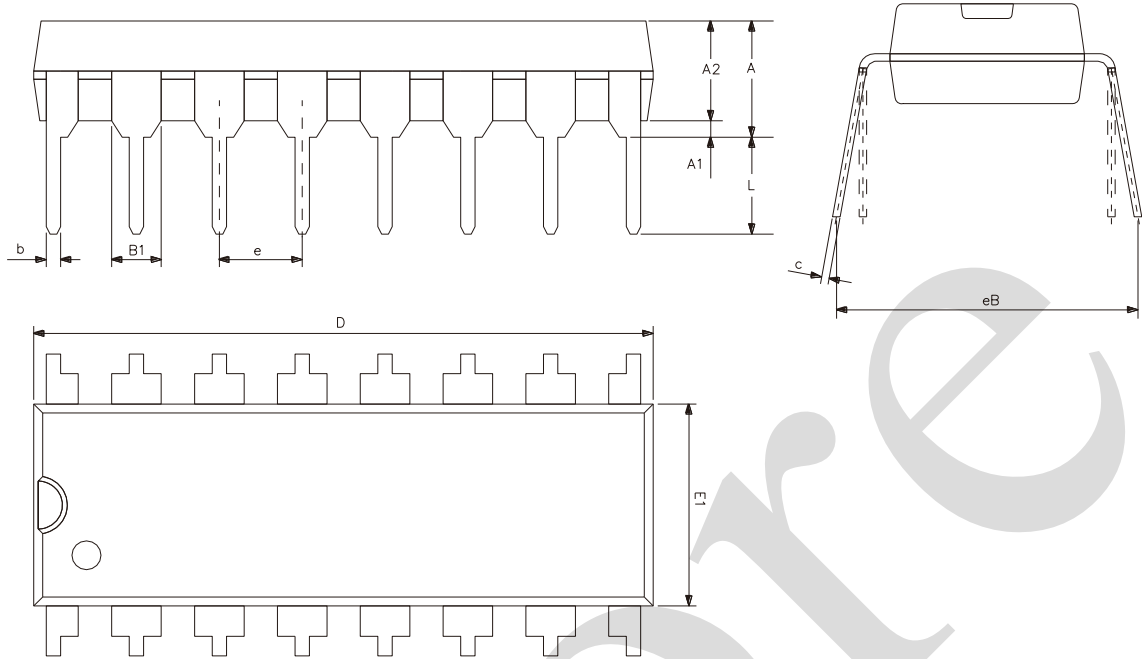

Symbol	Dimensions (mm)	
	Min.	Max.
A2	3.20	3.60
A1	0.51	-
A	3.60	5.33
L	3.00	3.60
b	0.36	0.56
B1	1.52	
D	18.80	19.94
E1	6.20	6.60
e	2.54	
c	0.20	0.36
eB	7.62	9.30



5.2、SOP16

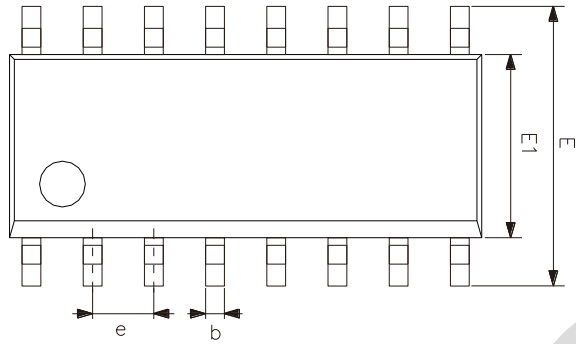
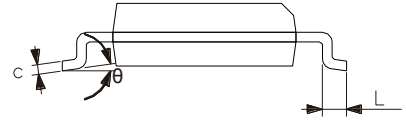
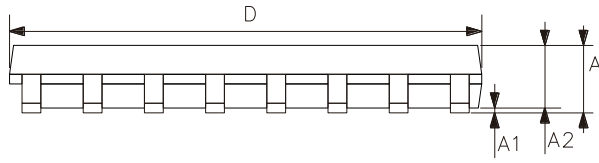

Symbol	Dimensions (mm)	
	Min.	Max.
A	1.35	1.80
A1	0.10	0.25
A2	1.25	1.55
b	0.33	0.51
c	0.19	0.25
D	9.50	10.10
E	5.80	6.30
E1	3.70	4.10
e	1.27	
L	0.35	0.89
θ	0°	8°



5.3. TSSOP16

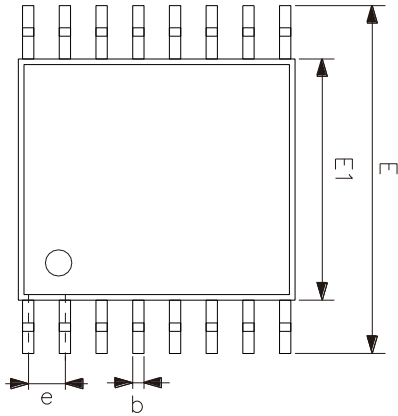
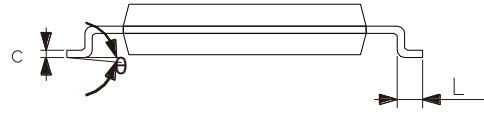
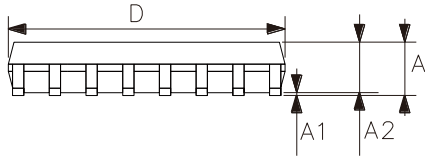

Symbol	Dimensions (mm)	
	Min.	Max.
A	-	1.20
A1	0.05	0.15
A2	0.80	1.05
b	0.19	0.30
c	0.09	0.20
D	4.90	5.10
E1	4.30	4.50
E	6.20	6.60
e	0.65	
L	0.45	0.75
θ	0°	8°



6、 Statements And Notes

6.1、 The name and content of Hazardous substances or Elements in the product

Part name	Hazardous substances or Elements									
	Lead and lead compounds	Mercury and mercury compounds	Cadmium and cadmium compounds	Hexavalent chromium compounds	Polybrominated biphenyls	Polybrominated biphenyl ethers	Dibutyl phthalate	Butylbenzyl phthalate	Di-2-ethylhexyl phthalate	Diisobutyl phthalate
Lead frame	○	○	○	○	○	○	○	○	○	○
Plastic resin	○	○	○	○	○	○	○	○	○	○
Chip	○	○	○	○	○	○	○	○	○	○
The lead	○	○	○	○	○	○	○	○	○	○
Plastic sheet installed	○	○	○	○	○	○	○	○	○	○
explanation	○: Indicates that the content of hazardous substances or elements in the detection limit of the following the SJ/T11363-2006 standard. ×: Indicates that the content of hazardous substances or elements exceeding the SJ/T11363-2006 Standard limit requirements.									

6.2、 Notes

We Recommend you to read this chapter carefully before using this product.

The information in this chapter is provided for reference only and i-Core disclaims any express or implied warranties, including but not limited to applicability, special application or non-infringement of third party rights.

This product is not suitable for critical equipment such as life-saving, life-sustaining or safety equipment. It is also not suitable for applications that may result in personal injury, death, or serious property or environmental damage due to product malfunction or failure. I-Core will not be liable for any damages incurred by the customers at their own risk for such applications.

The customer is responsible for conducting all necessary tests i-Core's application to avoid failure in the application or the application of the customer's third party users. I-Core does not accept any liability.

The Company reserves the right to change or improve the information published in this chapter at any time.

The information in this chapter are subject to change without notice. We recommend the customer to consult our sales staff before purchasing.

Please obtain related materials form i-Core's regular channels and we are not responsible for its content if it is provided by sources other than our company.

In case of any conflict between the Chinese and English version, the version is subject to the Chinese one.